

1:10TH XL READY-TO-RUN 4WD TRAIL VEHICLE



FRANÇAIS INSTRUCTIONS – PAGE 11
DEUTSCH INSTRUCTIONS – PAGE 20

INSTRUCTION BOOK AND COMPONENT LISTING



www.ftx-rc.com





FTX KANYON 1/10TH XL SCALE 4WD READY-TO-RUN RESCUE TRAIL VEHICLE

Congratulations on your purchase of the 'FTX Canyon Mountain Rescue 1/10th XL Scale 4wd Ready-To-Run Trail Vehicle'.

This 1/10th XL scale model has been factory assembled and all electrics installed and set up to make it the easiest possible introduction to the sport of driving RC cars.

Safety Precautions and Warnings

- You are responsible for operating this model such that it does not endanger yourself and others, or result in damage to the product or the property of others.
- This model is controlled by a radio which is possibly subject to interference which can cause momentary loss of control so it is advisable to always keep a safe distance to avoid collisions or injury.
- Age Recommendation: 14 years or over. This is not a toy. This product is not intended for use by children without direct adult supervision.

Carefully follow these directions and warnings, plus those of any additional equipment associated with the use of this model, fuel, starting equipment, engine, radio etc.

- Never operate your model with low transmitter batteries.
- Always operate your model in an open area away from cars, traffic or people.
- Never operate the model in the street or in populated areas.
- Do NOT touch equipment such as the engine heatsink head and exhaust pipe, immediately after using your model because they can generate high temperatures.
- Always keep the vehicle in direct line of sight, you cannot control what you cannot see!
- Keep all chemicals, small parts and anything electrical out of the reach of children.
- Although the model includes waterproof servos and receiver, the model and engine are not suited to extensive running in wet weather conditions. Long term damage can occur to the model and particularly the engine if run in prolonged wet conditions.
- Avoid injury from high speed rotating parts, gears and axles etc.
- Novices should seek advice from more experienced people to operate the model correctly and meet its performance potential.
- Exercise caution when using tools and sharp instruments.
- Do not put fingers or any objects inside rotating and moving parts.
- Take care when carrying out repairs or maintenance as some parts may be sharp.
- Always turn on your transmitter before you turn on the receiver in the car. Always turn off the receiver before turning your transmitter off.
- Keep the wheels of the model off the ground, and keep your hands away from the wheels when checking the operation of the radio equipment or engine set-up.
- Prolong engine life by following the engine set-up and guidelines outlined within the manual.

Contents:

- FTX 1:10th XL Ready-To-Run 4WD Trail Vehicle
- Transmitter: 2.4GHz Steerwheel.
- Charger: USB 600mA Charger
- Battery: 7.2V 1800mAh NiMH



WARNING:

Read the ENTIRE instruction manual to become familiar with the features of the product before operating. Failure to operate the product correctly can result in damage to the product, personal property and cause serious injury.

This is NOT a toy and must be operated with caution and common sense. Failure to operate this product in a safe and responsible manner could result in damage, injury or damage to other property. This product is not intended for use by children without direct adult supervision.

It is essential to read and follow all the instructions and warnings in the manual, prior to assembly, set-up or use, in order to operate correctly and avoid damage or serious injury.





REQUIRED EQUIPMENT FOR OPERATION

1. Tools required for building and maintenance:

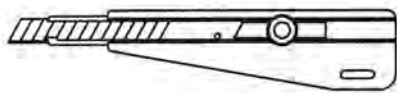

● Hobby knife

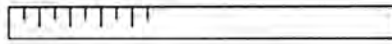

● Precision ruler

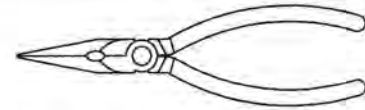

● Needle nose pliers

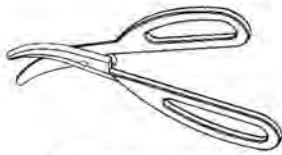

● Lexan scissors

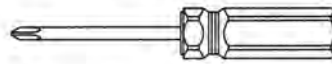
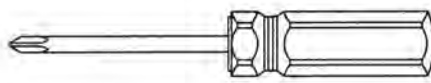

● Flat and Philips screwdriver

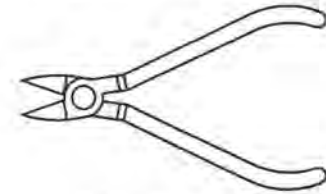

● Wire cutters

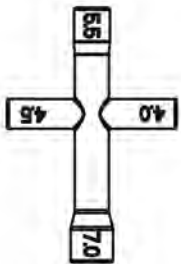

● Cross wrench

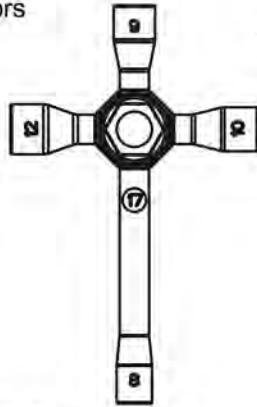

● Cross wrench



● CA glue&rubber cement

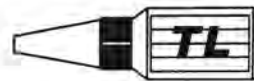

● Thread locking compound

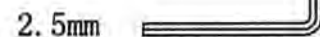

● Hex wrench

WARNING!

Do not use a power screw driver to install screws into nylon or plastic materials. The fast locking may heat up the screws being installed that may break the molded parts or strip the threads during installation.

2. Additional items needed for operation:

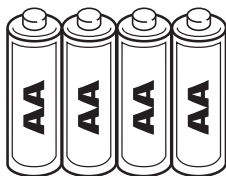

● 4 pcs AA Alkaline Batteries

IMPORTANT!

Check that all screws and nuts are tight before each use.



FIRST TIME SETTING UP OF THE BRUSHED ESC

1 Connection Diagram

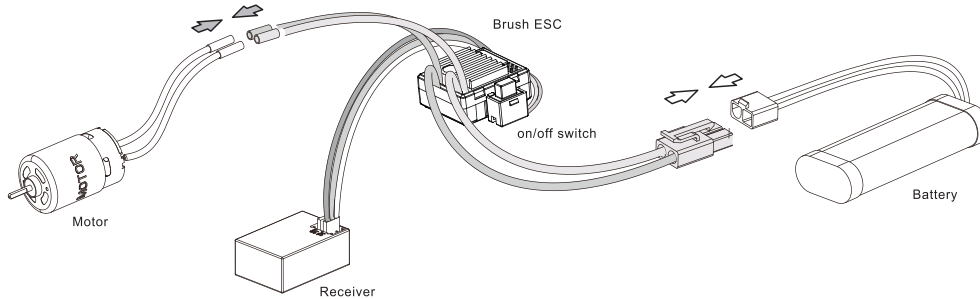

1. This Brush esc is not polarity protected. Please pay attention when you plug in. Make sure the battery polarity is correctly plugged into the ESC or we will not responsible for any loss.
2. Just change two motor wire if you find the rotation is wrong direction

Product Specification

Model	TB-60025	TB-60060
Forward: Continues/Peak current	25A/100A	60A/360A
Backward: Continues/Peak current	25A/100A	30A/180A
Battery type	1-2s Li-Po, 4-6cells Ni-mh	2-3s Li-Po, 5-9cells Ni-mh
Type of Model	1/18,1/24 onroad, offroad, bigfoot,Truggy	1/10,1/12,1/16 onroad, offroad,shortcourse,buggy, crawler,tank
Motor in Turn (T)	1s Lipo(Only support Lipo if 1cell is used)	030,050,280 motor rpm below 30000rpm@7.2v
	2s Lipo or 6cells Nimh	540,550motor ≥12T or below 30000rpm@7.2v
interal resistance	280,370,380 motor rpm below 30000rpm@7.2v	540,550motor ≥18T or below 30000rpm@7.2v
BEC Output Voltage	CW: 0.003Ω, CCW: 0.003Ω	CW:0.001Ω CCW:0.002Ω
Size/ Weight	1A/6v (Linear regulation)	3A/6v (switching regulation)
Mode	32.2*25.3*16.9mm/23.5g	34.5*30.2*18.7mm/39g
	Boat, Forward/Backward, Crawler	Boat, Forward/Backward, Crawler

2 Throttle setting

Turn on the transmitter, set Throttle D/R, EPA, ATL to 100%. Trim of throttle channel set to neutral. We strongly recommend to turn on failsafe function to cut off or neutral.

Turn on the ESC and set throttle trigger to neutral position. ESC will automatically self detection and calibration within 3s. Successful setting will sound "beep"

Battery type selection sound with "Beep"	LED indication when operation
•Short one beep , Nimh battery	•LED off when throttle trigger at neutral position
•short two beep, 2s Lipo	•LED flash when throttle is not at full speed
•short three beep, 3s Lipo	•LED solid on when throttle is at full speed
•Long one beep, Normal operation.	

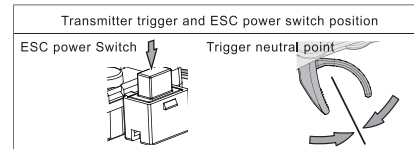

Mode and battery setting

Mode setting:

1. Mode and Battery are set by Jumper Pin

Setting method: Use Tweezers to select mode and battery type as illustration

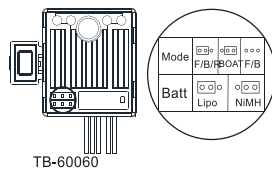

Setting:

1. Model Mode: Forward/Brake/Reverse, Boat, Crawler, Defaulted F/B/R

Meaning of Forward/Brake/Reverse is your model go forward then brake and reverse. When you going forward, pull trigger once is brake then pull once more is reverse. It prevents sudden reverse if pull the trigger

Boat mode only has forward and reverse without brake.
"Crawler mode: Forward and reverse with drag brake

2. Factory default battery setting: Li-po
(Factory default mode setting: Forward/Brake/Reverse)

Protection Features

1. Battery Protection: when ESC detect the battery level lower then the preset value. It enters protection mode(normally there two steps of protection. First is lower the power output, Second is cutoff the power)
2. Temperature protection: when internal temperature higher than 100°c. It will lower the motor output to prevent the car suddenly stop. LED flashing. It recover to normal when temperature below 80°c when boat mode is selected. The power will be cut to half when voltage low level. LED flashing rapidly. Please drive back to the shore as soon as you can

1s Lipo	2s Lipo	3s Lipo	5-9 cells Nimh
voltage drop to 3.2v. LED flash rapidly. power cut off	voltage drop to 6.5v. LED flash rapidly. power cut to half, when drop to 6v, LED flash slowly power cut off	voltage drop to 9.5v, LED flash rapidly. power cut to half. when drop to 9.0v, LED flash slowly power cut off	voltage drop to 4.5v, power cut to half, when drop to 4.0v power cut off



FAMILIARIZING YOURSELF WITH YOUR 2.4GHZ RADIO SYSTEM

SYSTEM FEATURES

- 2.4ghz FHSS
- Receiver 3mS response time
- 400-500m range
- Failsafe feature
- Transmitter voltage range 6V-7.4V (support 1s-2s) automatic identification of voltage, low voltage warning: 7.4V/4.8V
- Receiver voltage range: 3.3V-7.4V, working current 30mA, supports high voltage servos.

Binding Process

1. Press the receiver button and the LED indicator will flash fast indicating it is entering bind mode.
2. Turn on transmitter. The receiver will automatically look for the nearest transmitter signal.
3. Once binding is successful the LED will stop flashing and remain on.

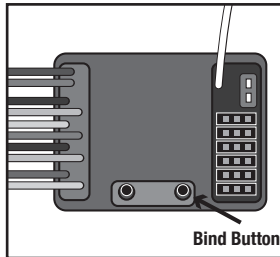

LED Light

1. Normal use: blue light flashes slowly.
2. Mixed direction for Tank mode: Red light is always on.
3. Low voltage warning: Yellow light flashes slowly.
4. Entering second menu level mode: Blue/Red light flashes quickly.

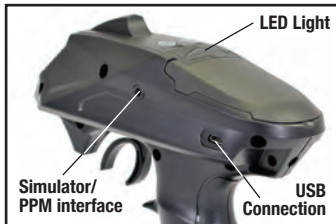
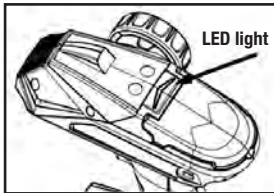

MENU SETTING:

To enter the program mode:

1. With the power off, move the steering wheel to its maximum forward position, hold this position and power on the transmitter.
2. The blue LED indicator will illuminate and remain solid, return the steering wheel to its neutral position, and press the CH3 button.

The LED indicator will now flash blue rapidly, indicating that you have entered program mode.

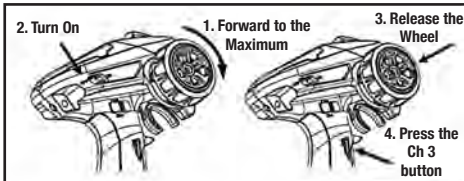

PROGRAM THE TRANSMITTER:

Once in program mode, the travel end points of CH1 and CH2 can be configured:

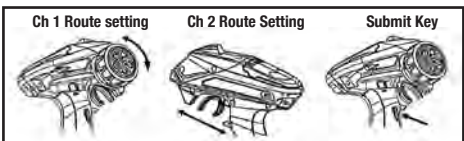

1. Rotate the steering wheel to its desired maximum position in both directions, returning it to its neutral position.
2. Pull/push the throttle trigger to its desired maximum position, forwards and backwards, returning it to its neutral position.
3. Once the steering wheel and throttle trigger have been in their neutral positions for 3 seconds, press the CH3 button once to save these settings.
4. The LED indicator will now flash steady blue, and the transmitter will operate normally. (Default factory settings are maximum travel for CH1 and CH2).

IF CH3 AND CH4 REQUIRE PROGRAMMING:

When in program mode, CH1 and CH2 EPA dials on the control panel can be used to set the travel of CH3 and CH4 respectively.

Once in program mode:

1. Rotate the steering wheel to its desired maximum position in both directions, returning it to its neutral position.

2. Pull/push the throttle trigger to its desired maximum position, forwards and backwards, returning it to its neutral position.
3. Rotate and position the CH1 dial to configure the desired travel for CH3.
4. Rotate and position the CH2 dial to configure the desired travel for CH4.
5. Once all end points and travel settings have been adjusted, press the CH3 button to save these settings.
6. The LED indicator will now flash steady blue, and the transmitter will operate normally.

Note: Each time program mode is initiated, all settings are erased and must be reconfigured.

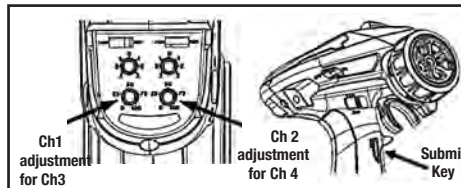

MODE SWITCH:

To switch from 'Normal Mode' to 'Mixed Mode':

1. Push the throttle trigger to the maximum forward position and power on the transmitter. The LED indicator will rapidly flash blue.
2. Pull the trigger backwards to its maximum position, and release back to its neutral position. The LED indicator will now flash steady red/yellow to indicate that 'Mixed Mode' is enabled. To return to normal mode, repeat the above process ^. The LED indicator will flash steady blue to indicate that 'Normal Mode' is enabled.

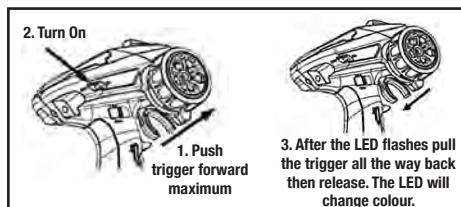

MIXED MODE (RC TANK OPERATION):

Mixed mode will allow the connection of two ESC and motor combinations, to channel 1 and channel 2 of the receiver. With mixed mode is enabled, when the throttle trigger (CH2) is pulled backwards or pushed forwards, this will control the forward or backward movement of the model. Each connected motor will operate at a continuous

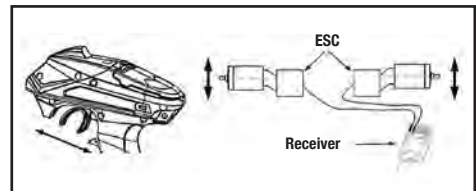

speed, however, the speed of each individual motor can be adjusted by rotating the steering wheel (CH1) in either direction. See diagrams.

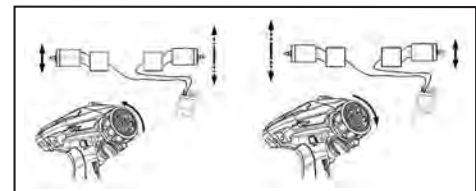

In mixed control mode, throttle direction, trim, neutral and end points can all be configured separately using the dials and switches on the control panel.

TRANSMITTER BATTERY INSTALLATION

1. Press down on the battery cover and slide in the direction of the arrow to remove.
2. Install 4 AA alkaline cells (or Ni-Cd, or Ni-MH) as indicated inside the battery compartment. Make sure to match the inside polarity the (+ and -) as shown in the battery compartment or the transmitter will not function.
3. Install the battery cover in place and slide to close.

WARNING:

Improper installation of transmitter batteries can cause serious damage to your system.

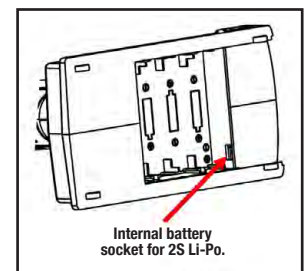



RECEIVER & SPEED CONTROL WIRING DIAGRAM

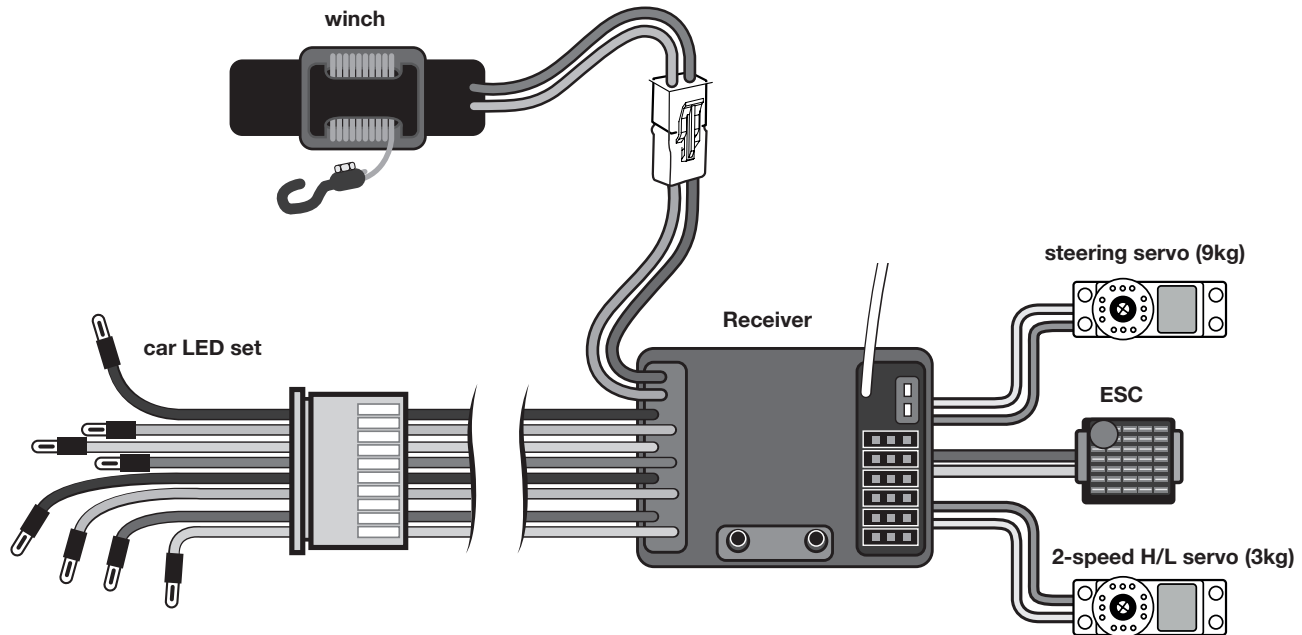

CHARGING

8 CHARGING/INSTALLING THE BATTERY

- Always store your model with the battery pack unplugged and removed.
- Always charge your battery away from the vehicle.
The included USB charger will take approximately 3 hours to charge a discharged 1800mAh battery.
- When charging the Red LED will be solid.
- When the battery is fully charged the Green LED will be solid.
- The battery will become warm to touch when charged, but not hot.
- If the battery is hot, stop charging immediately. Disconnect the battery from the charger as soon as the charger LED turns green.

9 NOTES ON BATTERY USE

- Always allow the battery cool after use, before recharging.
- Always inspect the battery before charging.
- Any bare wires, split heat shrink or leakage is a sure sign of abuse.
- Never attempt to charge dead or damaged batteries.
- Do not disassemble the battery or cut the connector wires.
- If the battery connector gets hot enough to melt there is most likely a serious problem with your model, driveline, battery wires or speed controller. Find and correct the problem before installing another charged battery pack.
- NEVER charge the battery unattended in case of overcharging, you need to be able to monitor the battery during charging.
- Charge away from flammable objects and on a non-flammable surface in case the battery becomes too hot.

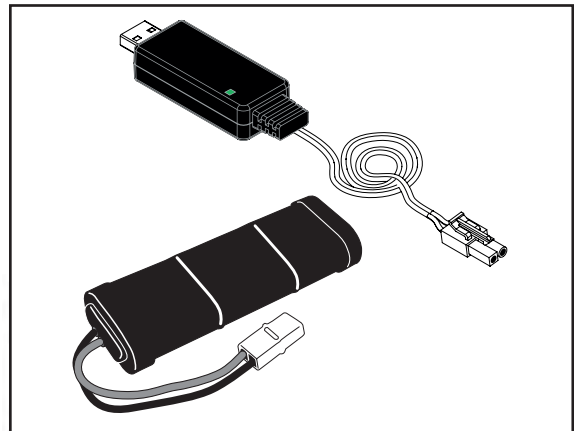



RUNNING YOUR CAR

1. TURNING ON THE RECEIVER OF YOUR CAR

The ESC Receiver switch is located under the side plate of the model. Switch on the ESC/Receiver Switch as shown in the picture.

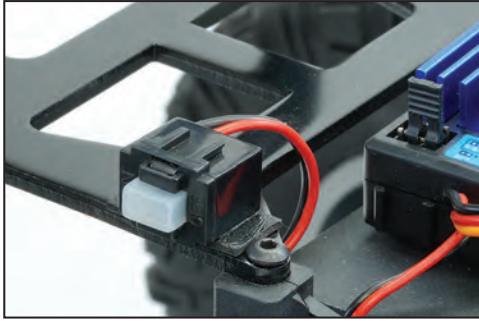

2. TURN ON THE RADIO CONTROLLER

Switch on the power switch on the radio controller. Your radio is bound with your car automatically.



3. CHECK STEERING PERFORMANCE

CENTRE

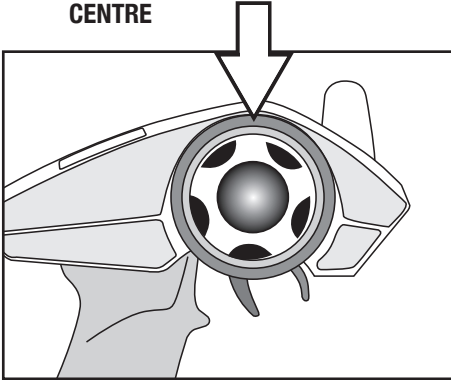

1. To keep the car running straight, keep the steering wheel centered.

TURN RIGHT

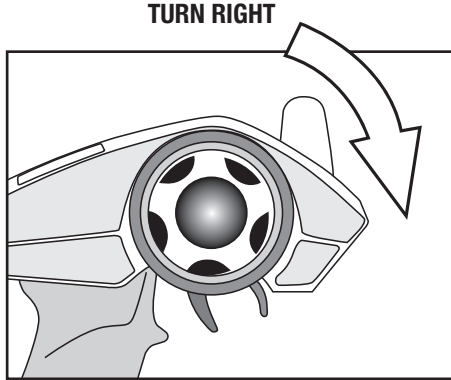

2. Turn the steering wheel to the right to allow the car to right.

TURN LEFT

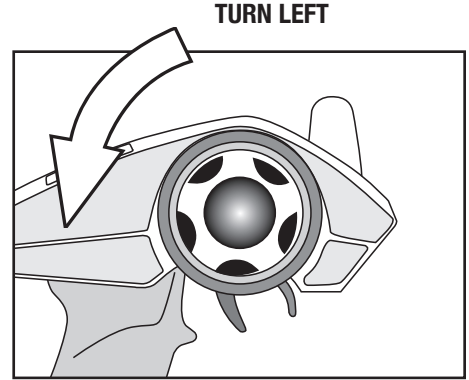

3. Turn the steering wheel to the left to allow the car to turn to the left.

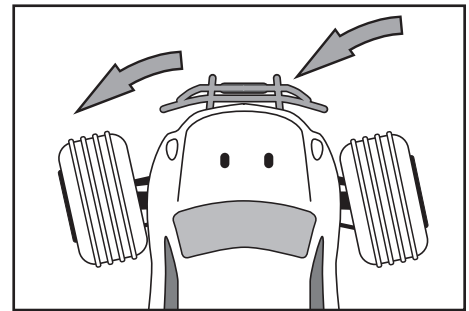
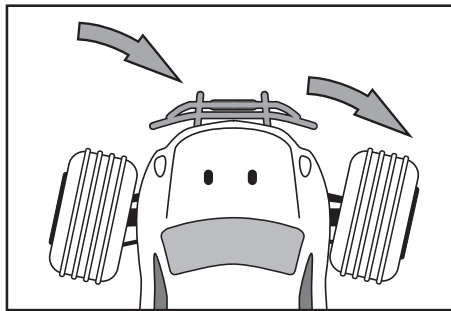
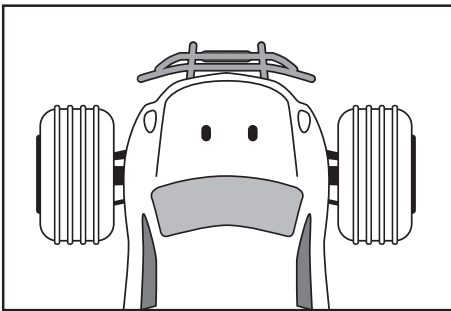

4. CHECK TRIGGER RESPONSE

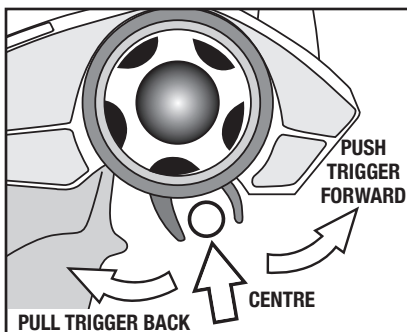

PLEASE NOTE: THE MODEL SWITCHES BETWEEN FORWARD AND REVERSE INSTANTLY FOR SLOW SPEED MANEOUVABILITY. EXCESSIVE USE OF THIS FEATURE CAN CAUSE TRANSMISSION AND ESC DAMAGE.

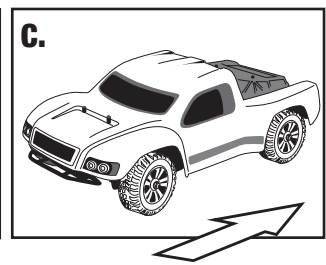
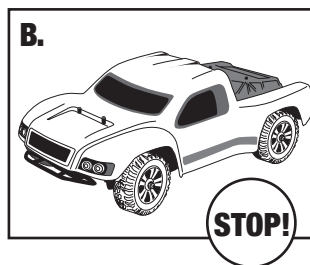
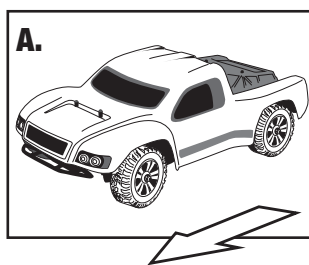

A. Pull the trigger back to accelerate, release it to decelerate.
B. To stop running your car, release the trigger to neutral.
C. Pushing the trigger forward activates reverse.



RUNNING YOUR CAR

5. TUNING THE STEERING TRIM

STEERING TRIM DIAL

Gently pull the trigger to allow your car to run slowly. Meantime, tune the steering trim to allow the front wheels to be aligned by rotating the dial.

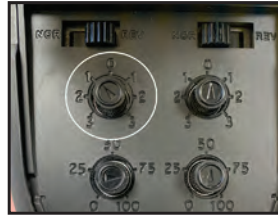

STEERING

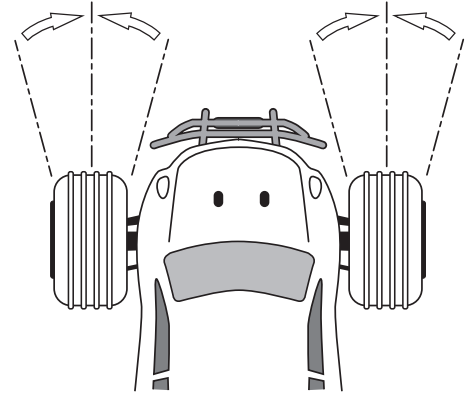

6. TUNING THE THROTTLE TRIM

THROTTLE TRIM DIAL

Throttle Trim is used to set the idle speed of the car, by rotating the dial.

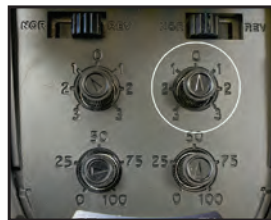

THROTTLE TRIM

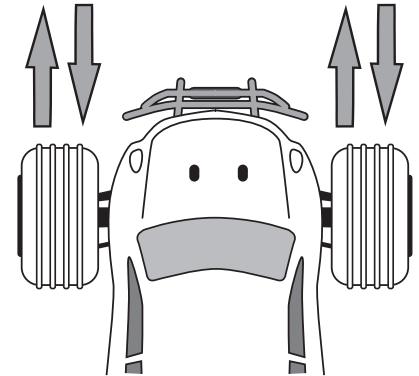

7. TO TUNE THE STEERING AND THROTTLE DUAL RATE CONTROL

STEERING D/R DIAL

The D/R controls the amount of servo travel. You should adjust this to give maximum steering without any extra strain on the servo.

Set it to minimum first and then slowly adjust until full steering is achieved.

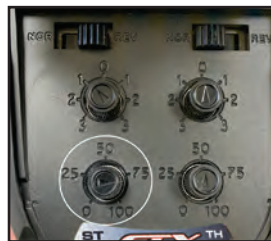

STEERING D/R

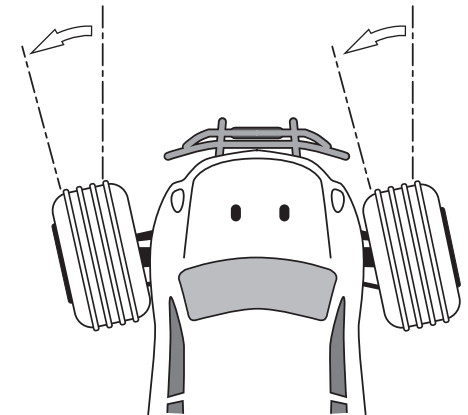

THROTTLE D/R

With this dial you can adjust the the maximum power output from your speed control.

8. STEERING/THROTTLE REVERSE

STEERING REVERSE:

To reverse the direction of servo travel for steering (CH1).

THROTTLE REVERSE:

Allows you to electronically switch the direction that the motor operates in relation to the throttle trigger. For example, if you pull the throttle trigger to accelerate forward but the model goes in reverse, flip the Throttle Reverse switch to make the model accelerate forward.





TWO-SPEED FUNCTION

Use the 3rd channel to control the 2-speed High/Low servo. Insert the servo connector into the 3rd channel on the receiver. Make sure polarity is correct. The pin on the left side of the receiver is the signal pin, the middle pin positive and the right side is negative.

Press the Ch3 button on the transmitter for the servo operated high or low speed. When in low speed the button LED light will be ON. In high speed the LED light will be OFF.

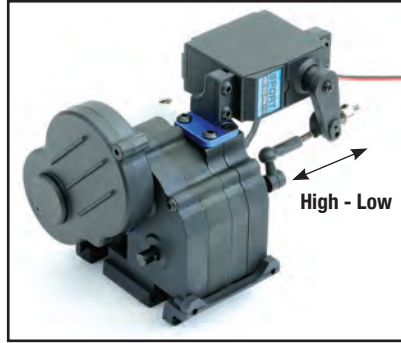
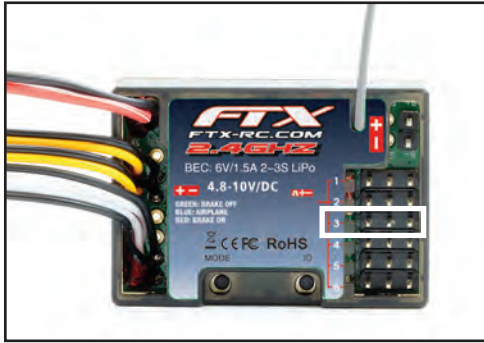

LED LIGHTS CONNECTION AND FUNCTIONS

Note: The voltage output of the receiver is 5V so the LED lights used must support a voltage of 5V, or 6V. The LED bulb has to be connected to the receiver correctly. Make sure your LED lights come with a JST or similar connector suitable for receiver. Make sure the polarity is correct before connecting the LED lights.

1. DETAILS FOR CONNECTING CAR LED LIGHT WIRES TO RECEIVER WIRES.



Connect wires as per their tag: L to L, R to R, S to S and F to F.

Pay attention to the polarity. Wire colour must be same when connecting to each connector. E.G. black aligned with black, yellow aligned with yellow.

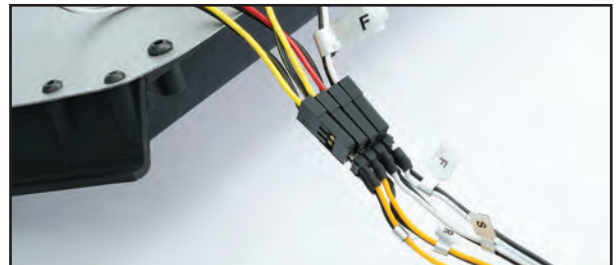

2. LED LIGHTING FUNCTIONS.



slide switch to right

The Ch4 is a slide switch that has 3 positions for different LED light functions.

Slide the Ch4 switch all the way to the right for the roof lamps and headlights to be fixed on.



slide switch to centre

Slide the Ch4 to the centre position for the roof lamps and headlights to be in flashing mode.





Slide the Ch4 switch all the way to the left position for the roof lamps and headlights to be turned off.



Push the trigger forward to brake/ reverse for rear red light to come on.



Turn steering wheel clockwise for right indicator lights to flash front and rear.



Turn steering wheel counter-clockwise for left indicator lights to flash front and rear.



3. WINCH CONTROL.

Press the right button on the transmitter to pull the winch cable out. Release the button and the winch motor will stop.

Press the left button on the transmitter to retract in the winch cable. Release the button and the winch motor will stop.

Note: Always keep the cable straight to avoid knotting when pulling or retracting.





Getting Started

Switch on transmitter. Hold vehicle clear of the ground, connect battery pack and switch on receiver. Bind the Transmitter and receiver if required.
Test the transmitter to check control of the vehicle with wheels off the ground.
Start driving slowly and if the vehicle does not go straight, adjust steering trim dial on Transmitter. For the very first run use the throttle gently, to gradually bed in the motor brushes and help the driver become accustomed to the vehicles behaviour and controls.

PLEASE NOTE:

Although the electronics are waterproof the rest of car can be subjected to damage if running in excessively wet or submerged conditions.

After Run.

Switch off the receiver power, switch off the transmitter and lower the aerial.
Disconnect the battery and remove it from the vehicle, allow it to cool before recharging. If you have a second charged battery all ready to use, still allow the vehicle to cool slightly before continuing.

Regular maintenance.

Frequently check the whole vehicle for loose or missing fixings. Use thread lock on any replacement screws into metal threads.
Frequently check rotating parts are free from grass, string etc. that might bind their motion and over stress the motor or speed controller. Remove the wheels occasionally and check behind the mounting hex for obstructions or anything that might have been wrapped around the axle and caused extra drag.
Shock absorbers will wear prematurely if used in dirty dusty conditions. Replace oil and seals as required to keep a smooth dampening action.

Warranty

Due to the nature of this product and potential use FTX warrants it to be free of material and workmanship defects when new. FTX will at its sole discretion repair or replace defective components free of charge within 30 days from date of purchase. This warranty does not cover wear and tear, crash or impact damage, modifications, component water damage failure to perform maintenance or damage from improper use. Proof of purchase date will be required to action any warranty claims. In no case shall FTX's liability exceed the original cost of the purchased kit.

Trouble shooting guide.

SHORT RUNTIME:	SLUGGISH ACTION:	MOTOR/ESC OVERHEAT:	MOTOR SPINS BUT VEHICLE REFUSES TO MOVE:	POOR RANGE OR FAILS TO OPERATE:
Battery damaged/not charged Motor dirty or brushes worn Drivetrain binding	Motor dirty or brushes worn Bind in drive train Battery running low on power	Over-gearred Binding transmission. Seized axle bearing. Motor binding	Gears damaged. Gears loose on shaft. Drive shaft broken or missing.	Transmitter batteries low Vehicle Battery Low. Transmitter switched off Transmitter/receiver aerial not extended. ESC switched off or battery not connected. Loose connectors/wires.

Instructions for disposal.

Environmental Protection Notes & WEEE

The crossed-out wheeled bin symbol shown here, which may be found on the product itself, in the operating instructions or on the packaging, is in accordance with the Waste Electrical and Electronic Equipment (WEEE) Directive. Individual markings indicate which materials can be recycled and re-used. You can make an important contribution to the protection of our common environment by re-using the product, recycling the basic materials or recycling redundant equipment in other ways.

When this product comes to the end of its useful life, you must not dispose of it in the ordinary domestic waste. Many electrical items that we throw away can be repaired or recycled. Recycling items helps to save natural resources and also reduces the environmental and health impacts that are linked with sending electrical goods to landfill. The correct method of disposal is to take it to your local collection point for recycling electrical and electronic equipment. You can go to recycle-more.co.uk for details of locations.

Alternatively FTX can offer our customers free take-back of their WEEE on a like-for-like basis when they buy a new Electrical or Electronic product from us. For example, if a customer bought a new radio system from us or a dealer, we would accept their old radio and prevent it going into a landfill site by disposing of it safely. Customers must return their old WEEE item to us within 28 days of purchasing their new item.

Remove batteries from your device and dispose of them at your local collection point for batteries. If you don't know the location of your nearest disposal centre, please enquire at your local council office.



CML Distribution, Saxon House, Saxon Business Park, Hanbury Road,
Bromsgrove, B60 4AD. WEE/GB4215VX





EXPLODED DIAGRAM PARTS LISTING

Central Transmission II (Bag J)

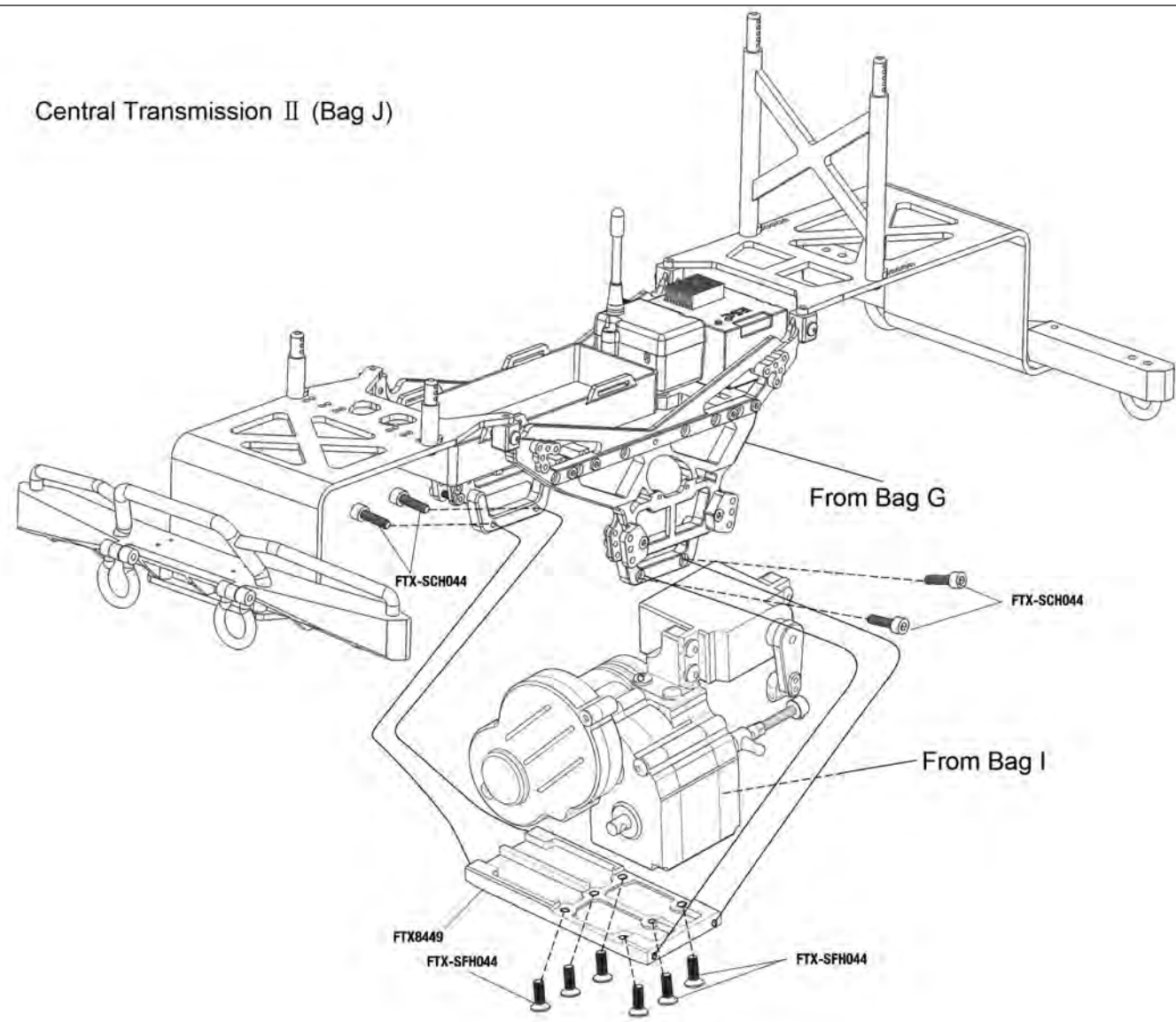

Linkages Assembly

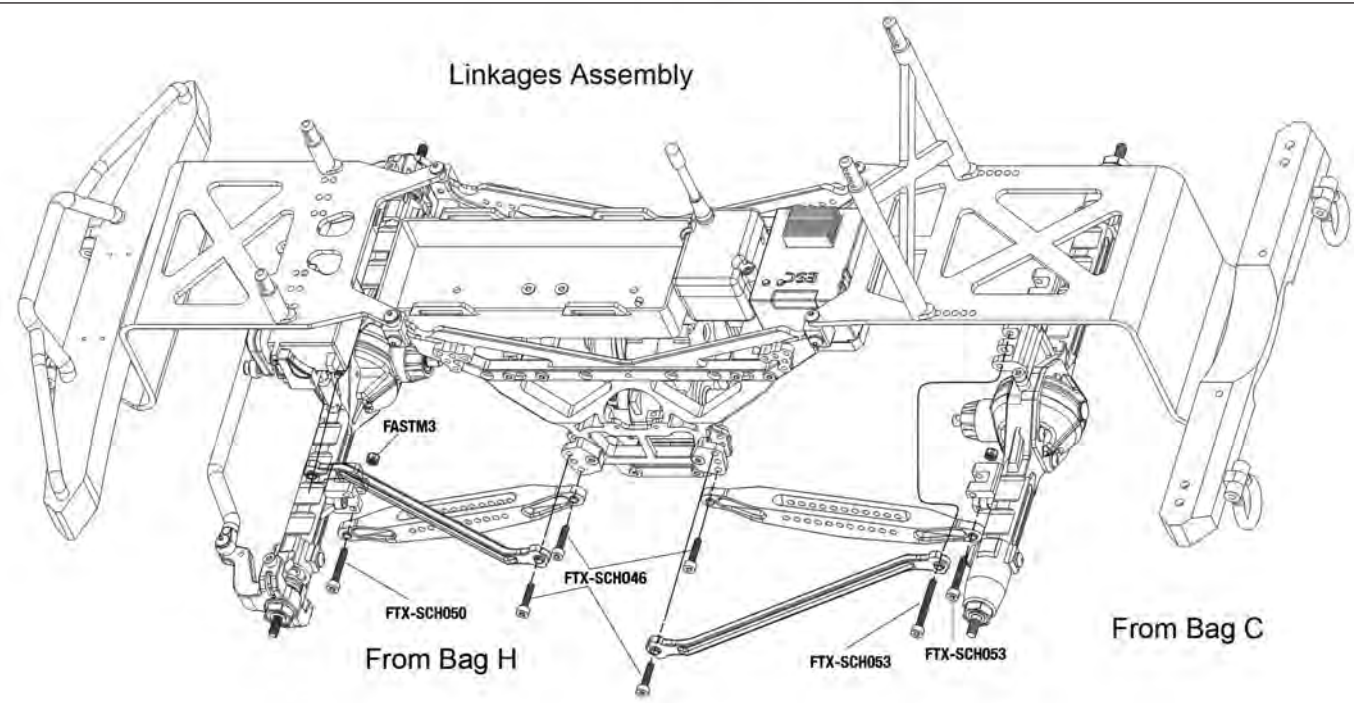

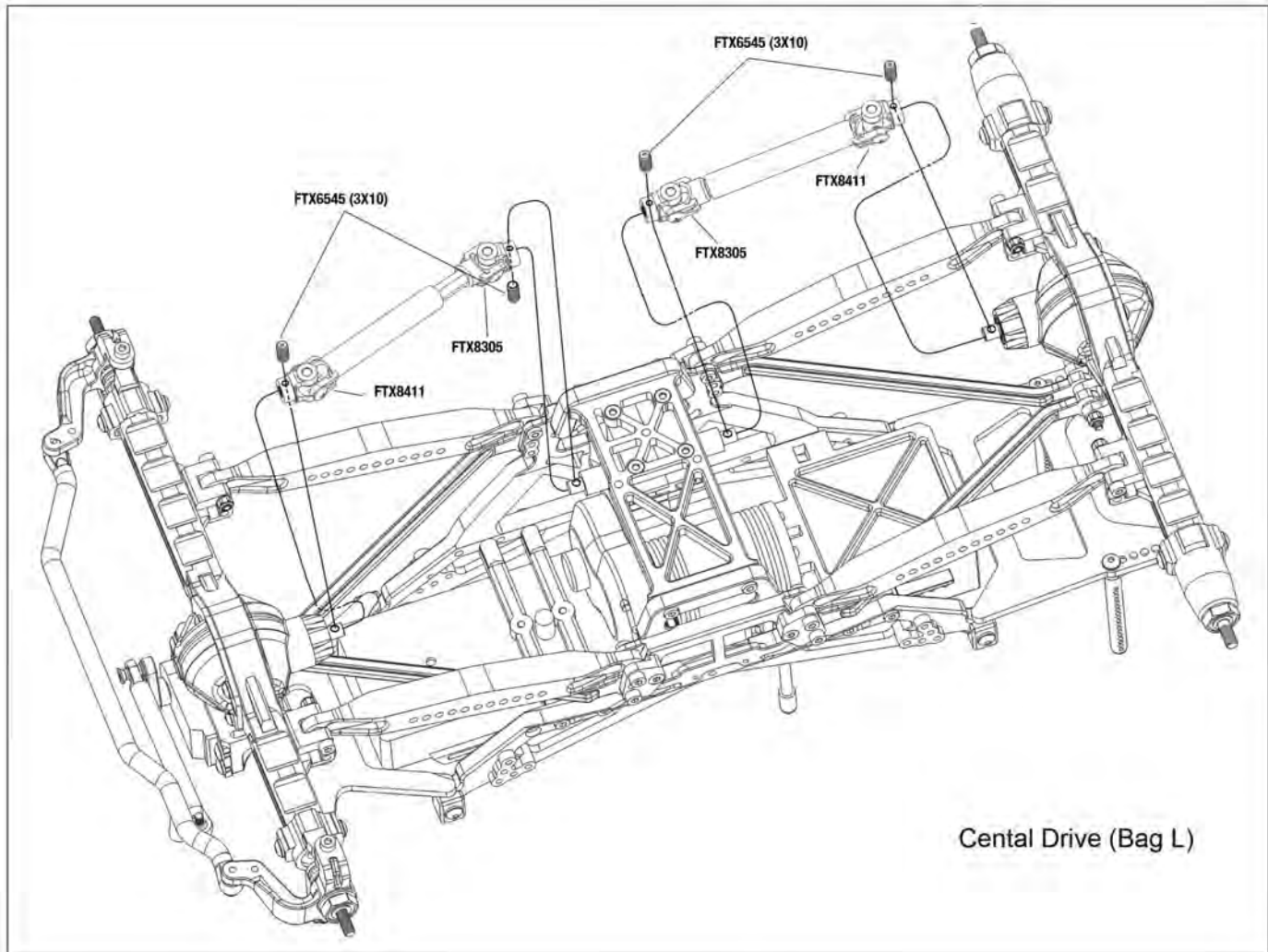

Cental Drive (Bag L)

Shocks Assembly

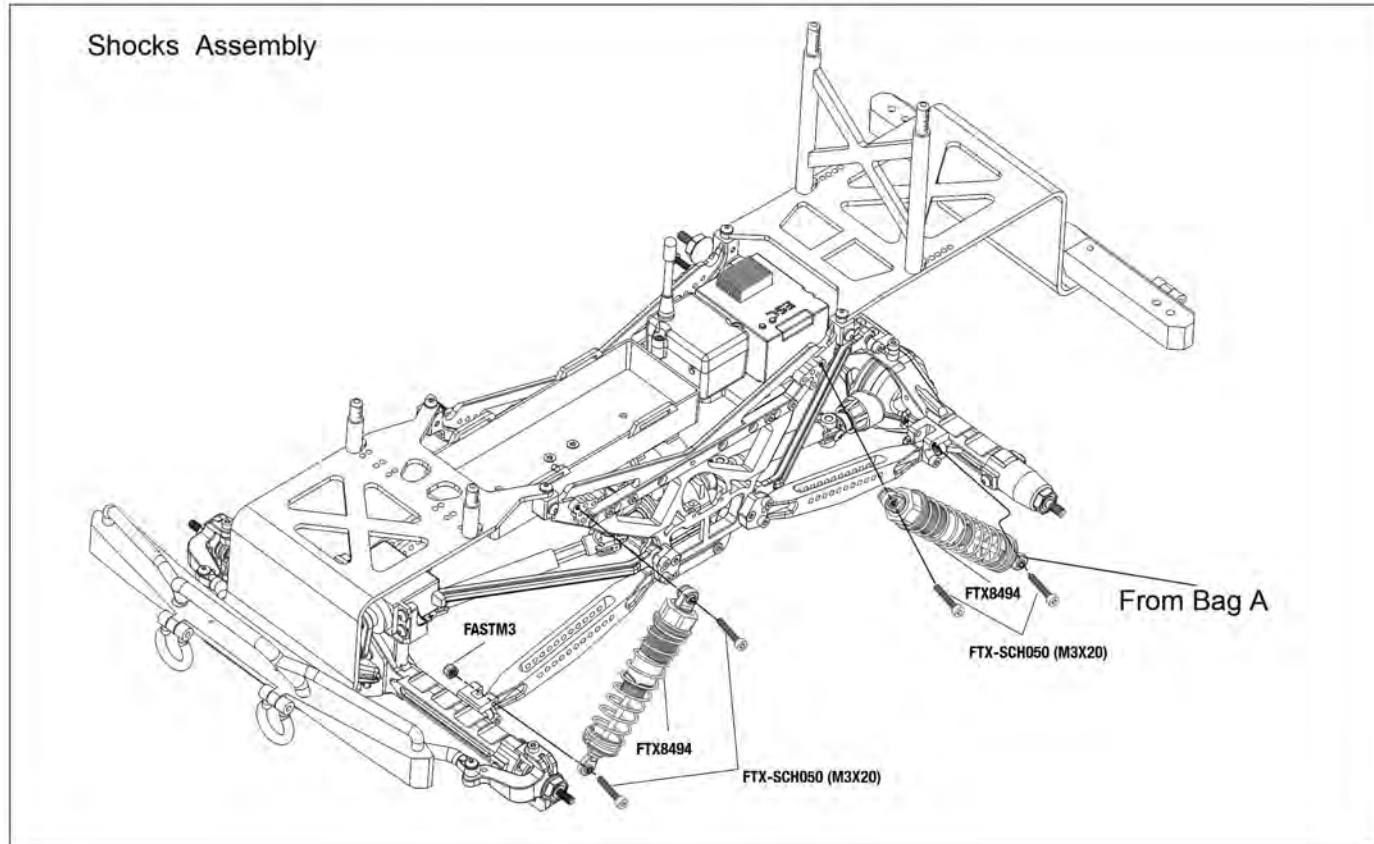



EXPLODED DIAGRAM PARTS LISTING

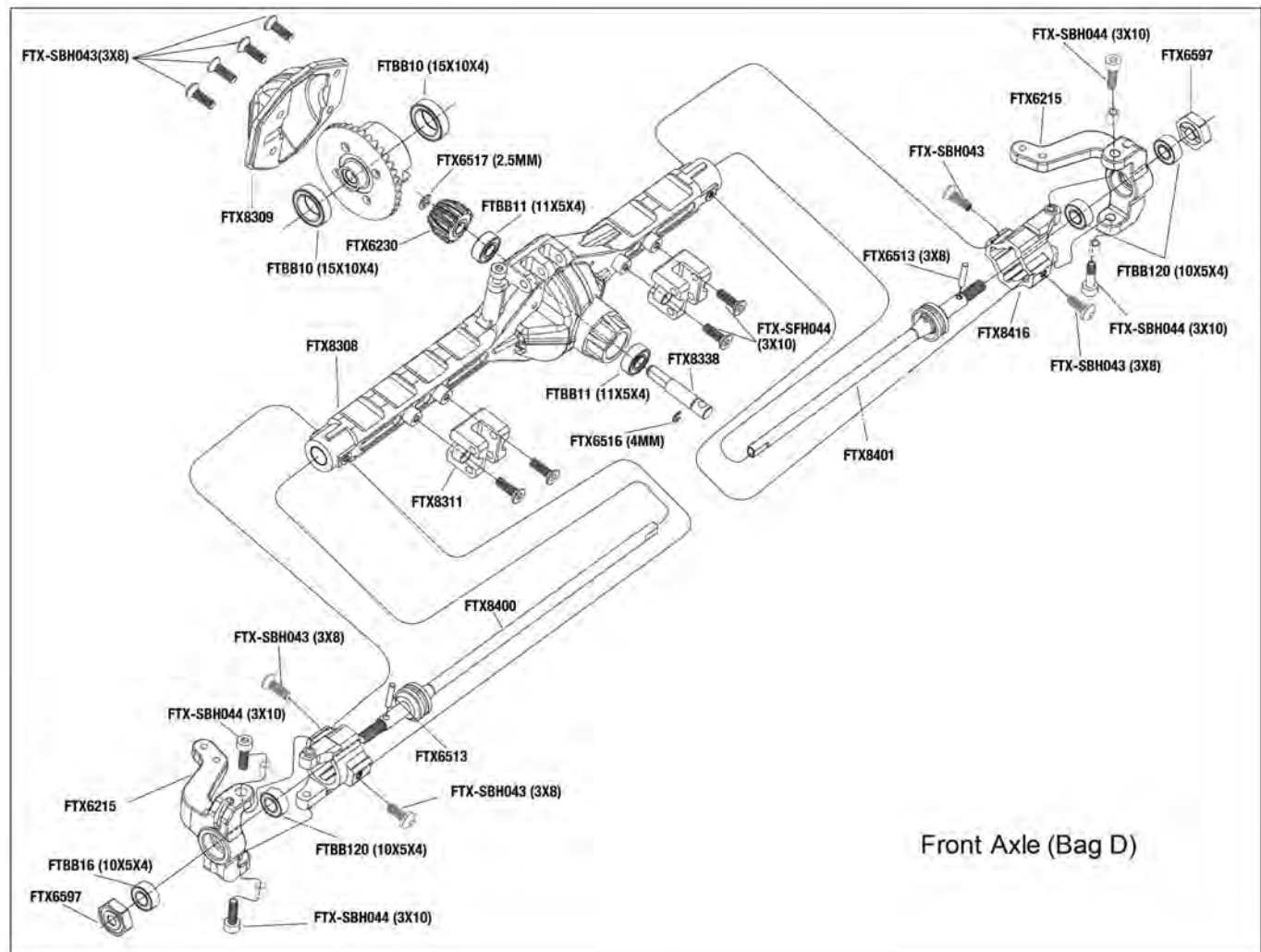
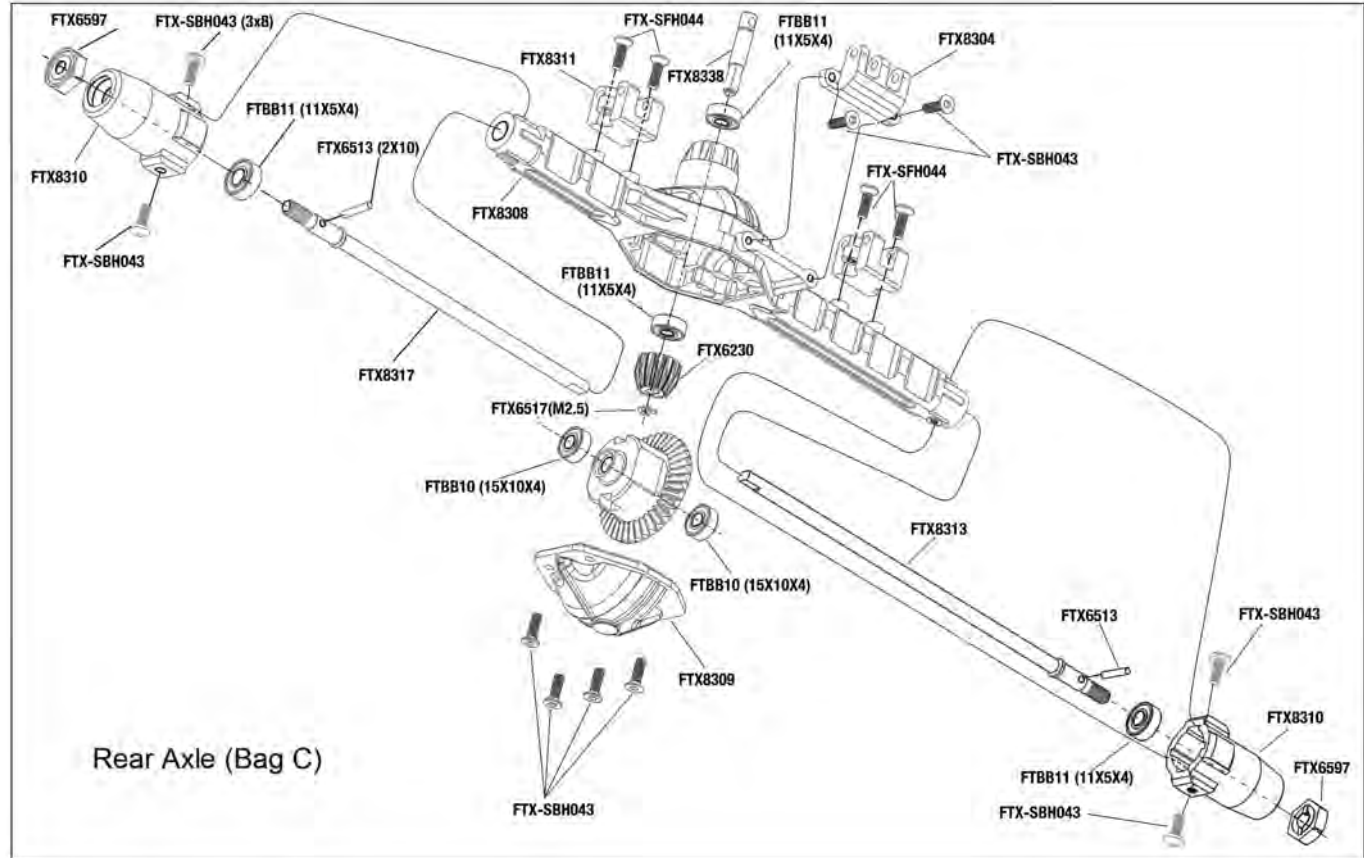



EXPLODED DIAGRAM PARTS LISTING

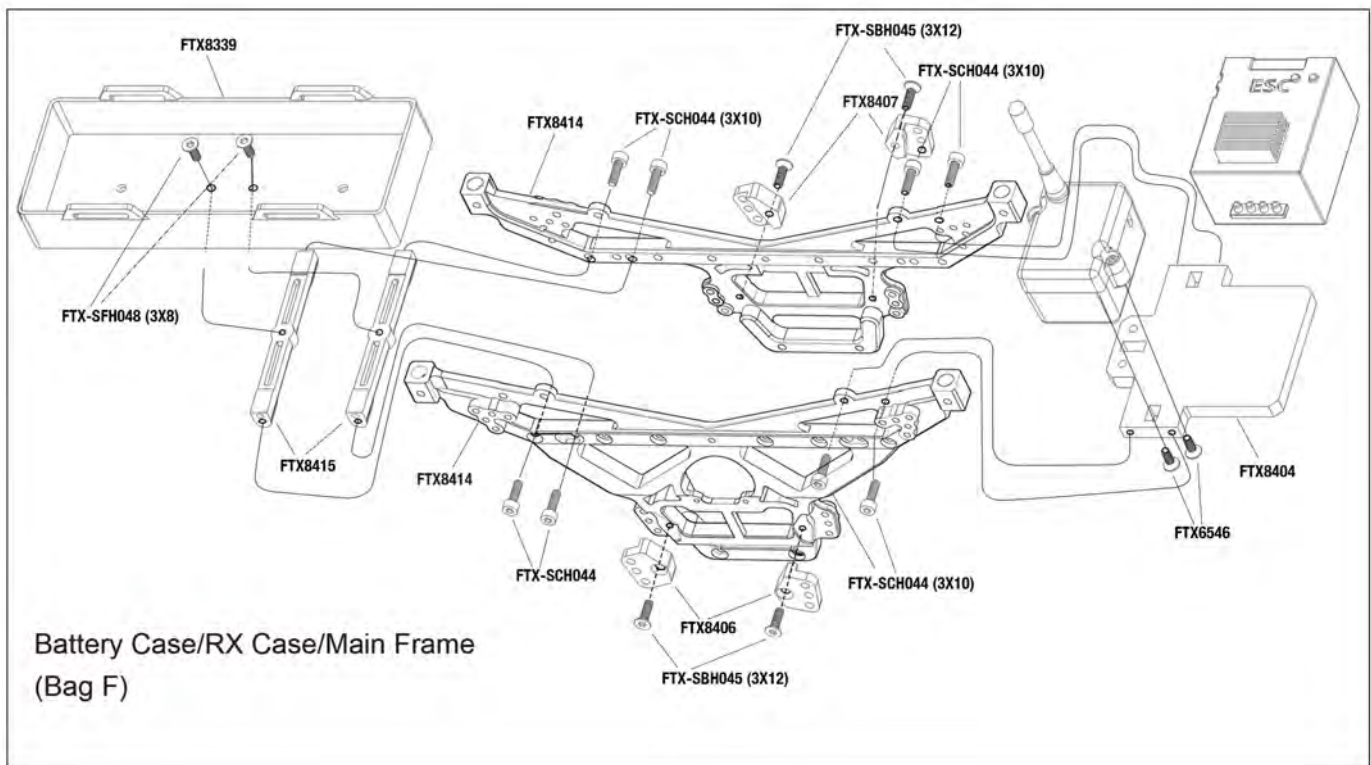
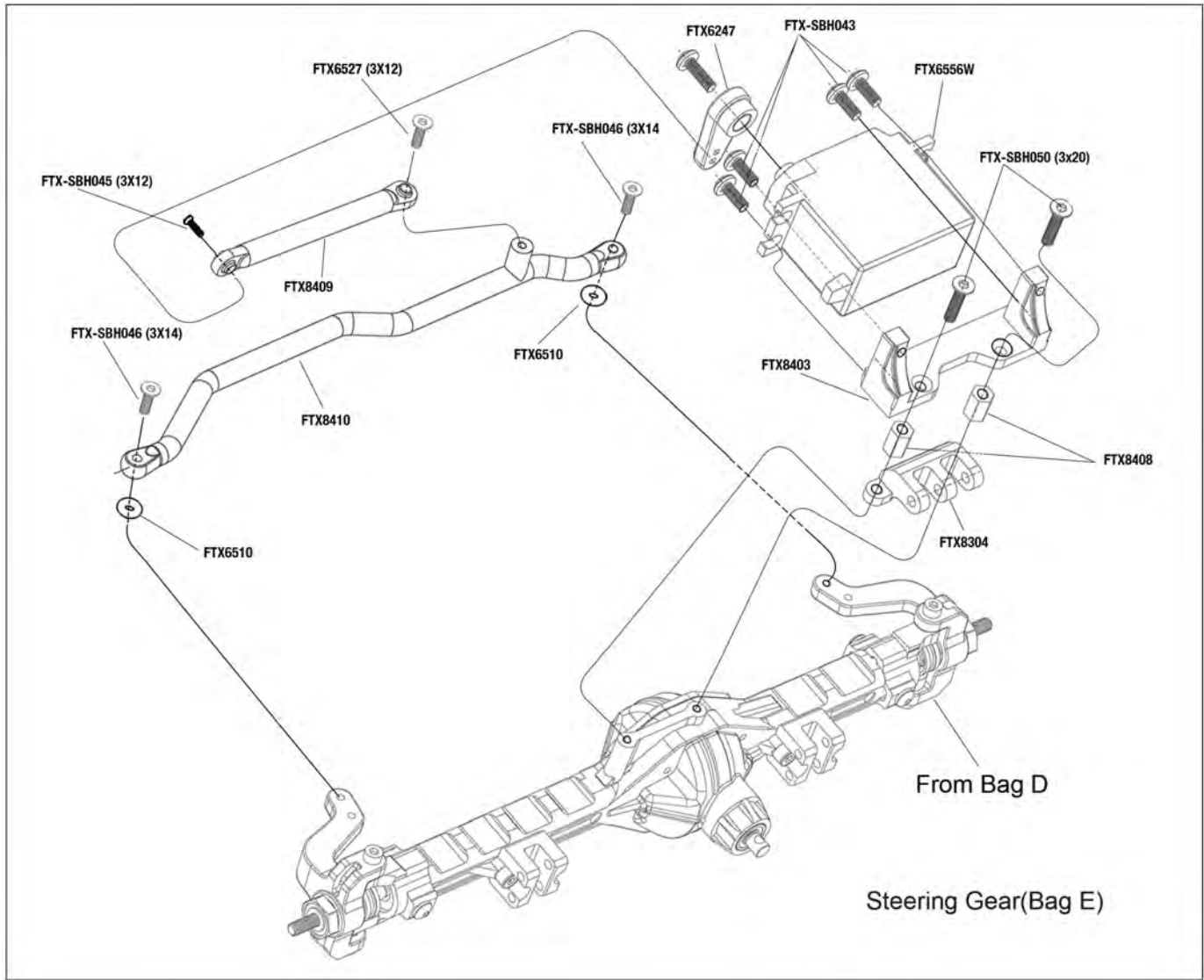



EXPLODED DIAGRAM PARTS LISTING

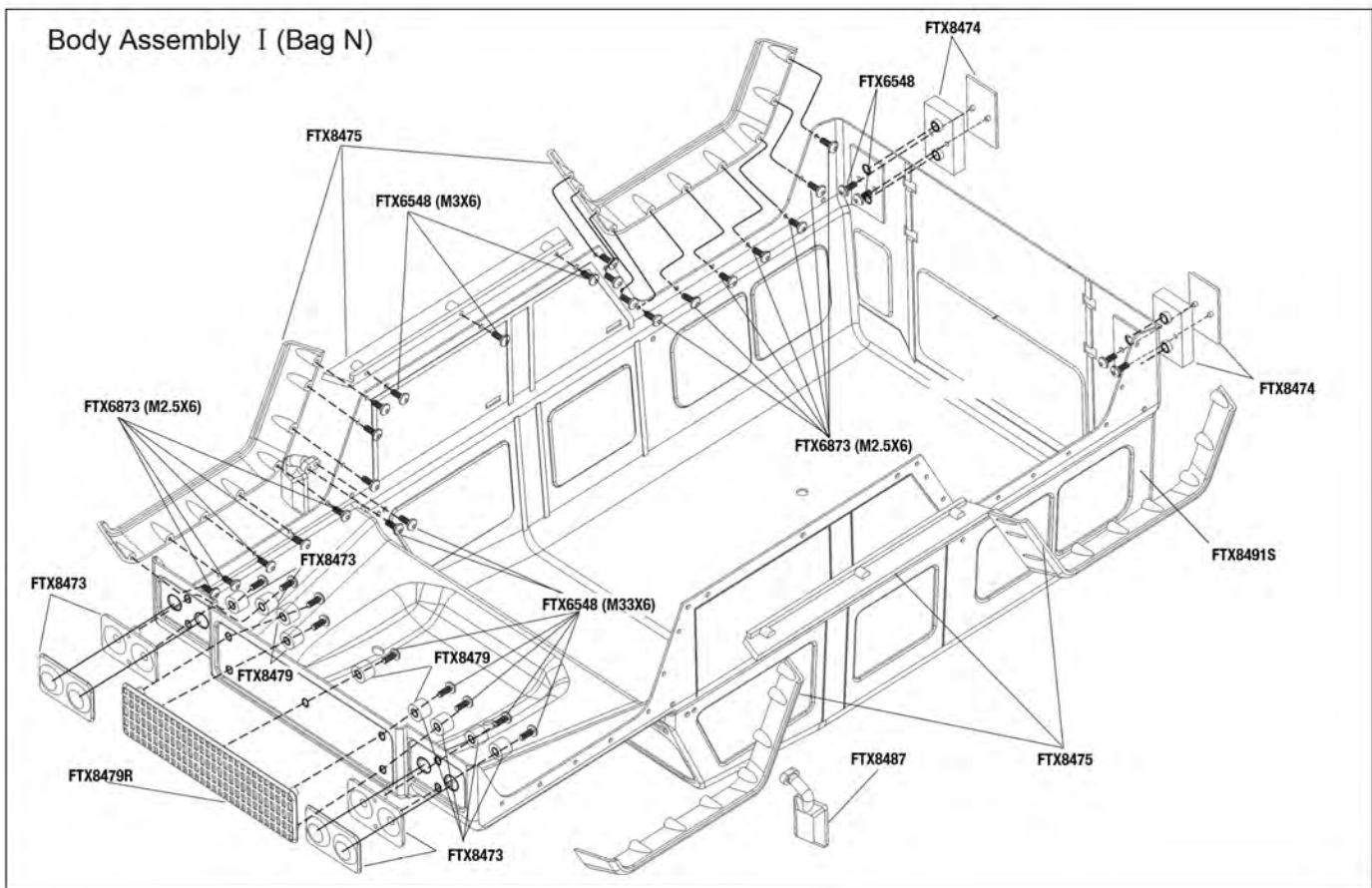
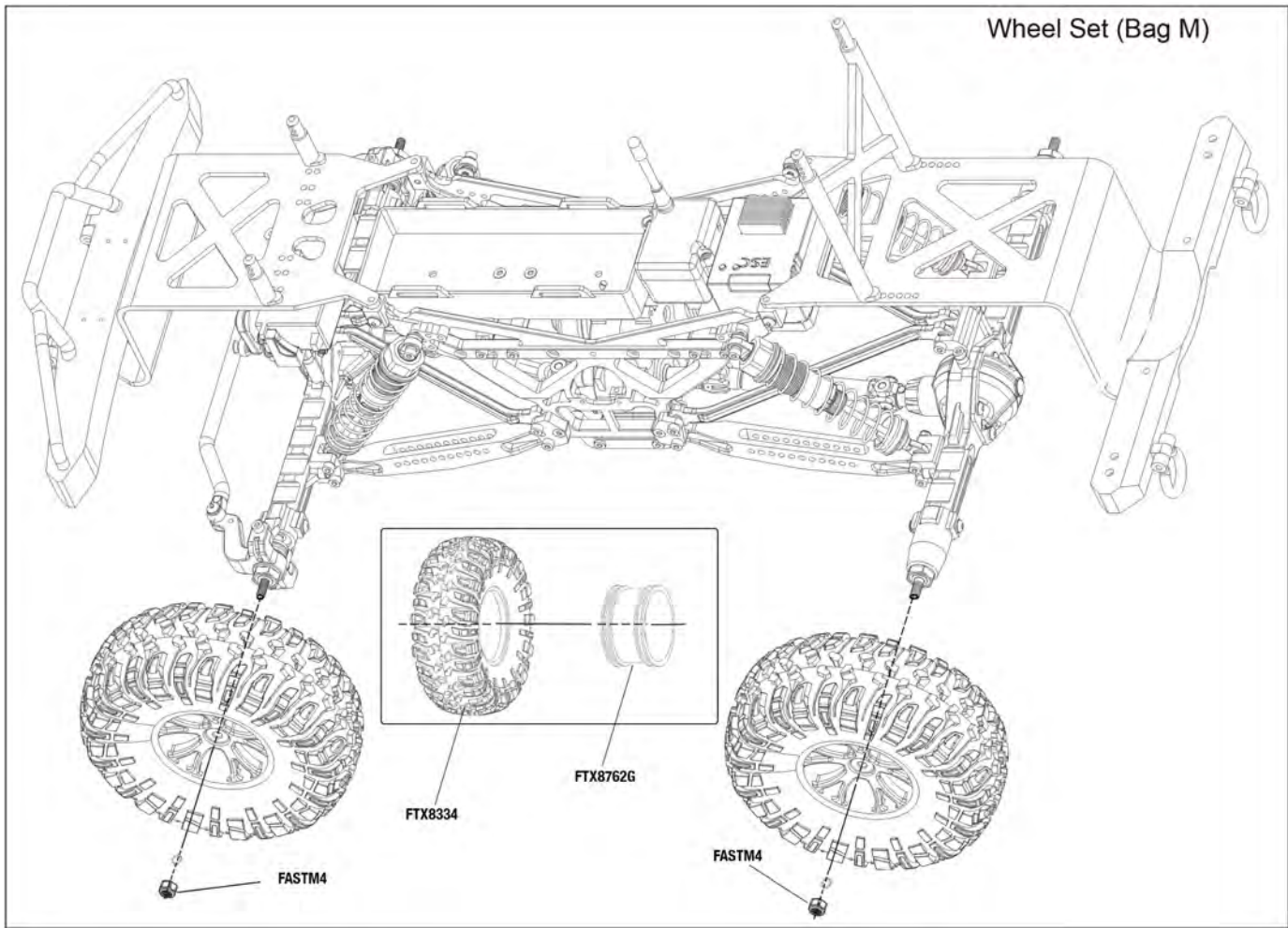



EXPLODED DIAGRAM PARTS LISTING

Roll Cage Assembly (Bag O)

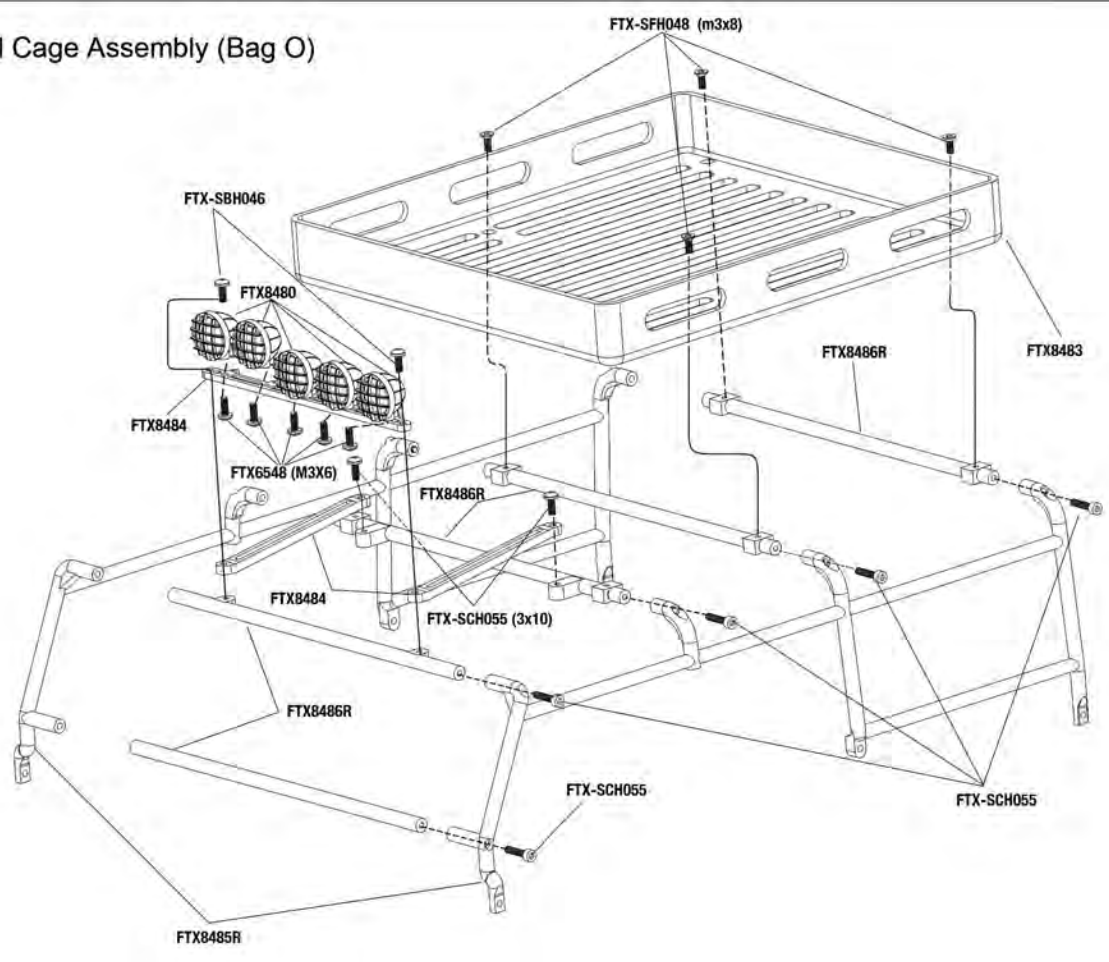

Body Assembly I (Bag P)

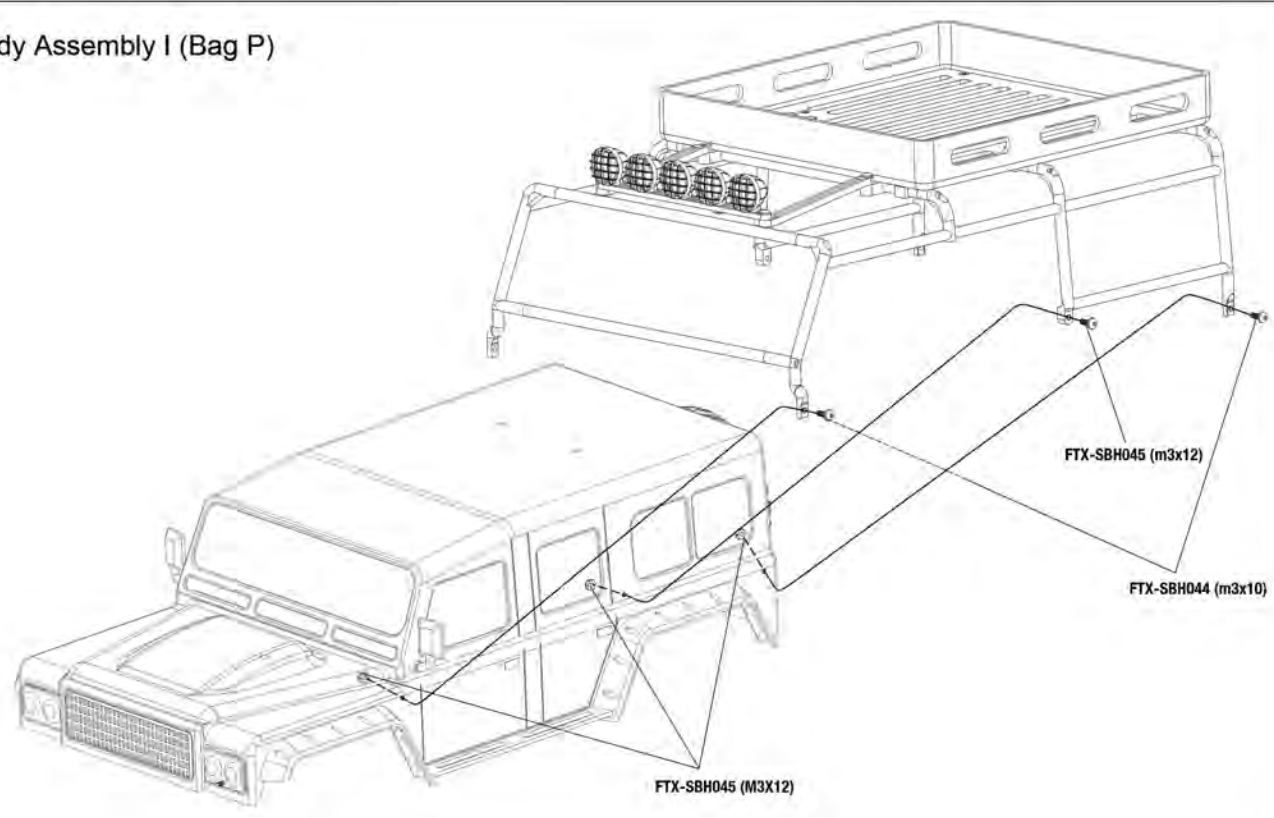



EXPLODED DIAGRAM PARTS LISTING

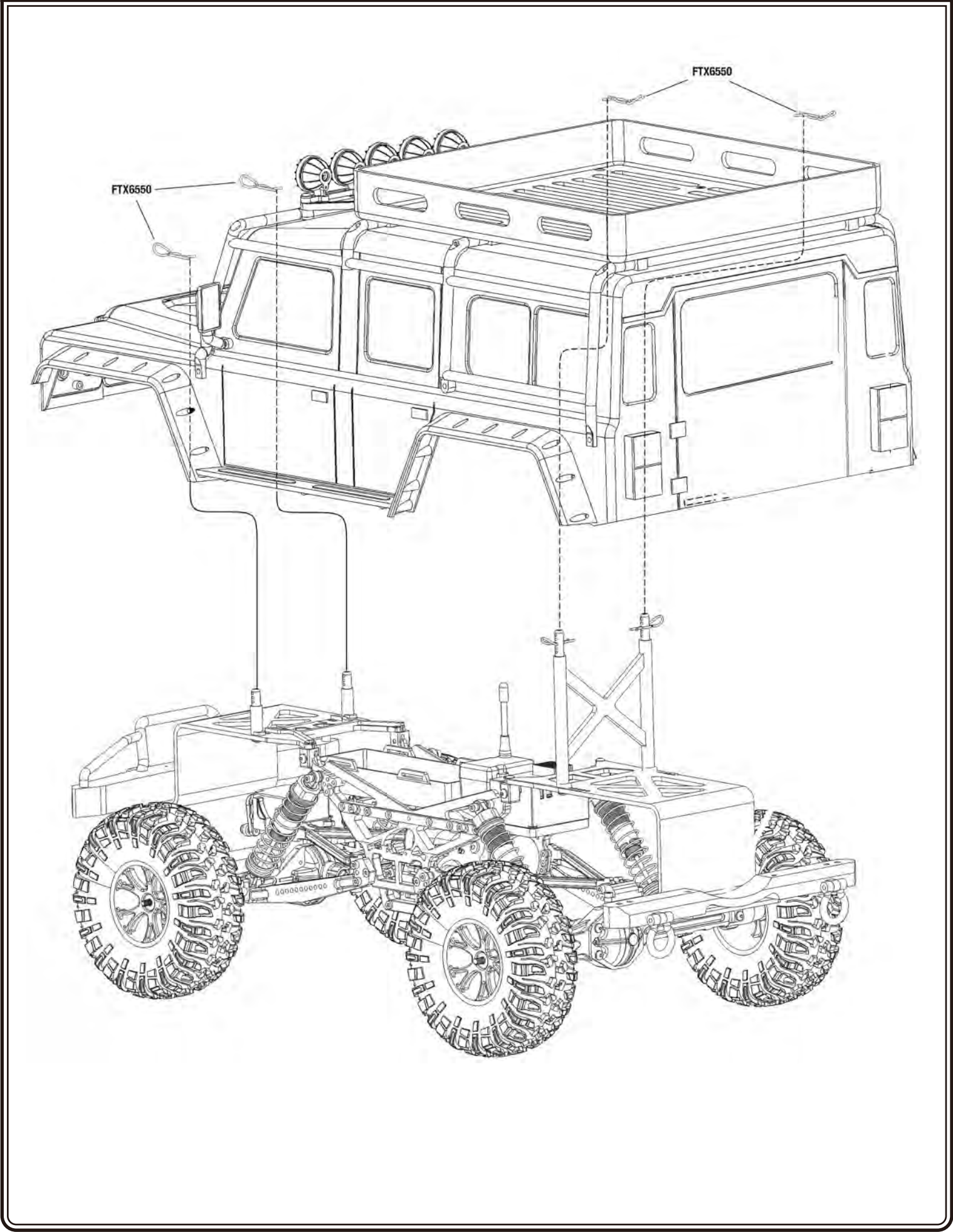



PARTS LISTING

<p>FTX8400 – CVD Long. 2 pcs</p>	<p>FTX8401 – CVD Short. 2 pcs</p>	<p>FTX8449 – Chassis Plate. 1 pc</p>	<p>FTX8403 – Servo Mount. 1 pc</p>
<p>FTX8404 – ESC Bracket. 1 pc</p>	<p>FTX8405 – Drive Coupler. 2 pcs</p>	<p>FTX8406 – Support Rod Holder L. 2 pcs</p>	<p>FTX8407 – Support Rod Holder R. 2 pcs</p>
<p>FTX8408 – Servo Mount Post. 2 pcs</p>	<p>FTX8409 – Steering Rod S. 1 pc</p>	<p>FTX8410 – Steering Rod L. 1 pc</p>	<p>FTX6215 – Steering Knuckle Arm. 2 sets</p>
<p>FTX8414 – Main Frame. 2 pcs</p>	<p>FTX8415 – Battery Case Holder. 2 pcs</p>	<p>FTX8416 – Steering Knuckle. 2 pcs</p>	<p>FTX8422 – Roll Cage Spacer. 4 pcs</p>
<p>FTX8423 – Central Diff. Shaft. 1 pc</p>	<p>FTX8334 – Tyres & Foam inserts. 2 pcs</p>	<p>FTX8496G – Preassembled Tyres. 2 sets</p>	<p>FTX8762G – Rim. 2 pcs</p>
<p>FTX8313 – Front/Rear Link Set. 2 pcs</p>	<p>FTX8323 – Front/Rear Shocks Lower Support Rod. 2 pcs</p>	<p>FTX6547 – E-Clip - 3mm. 6 pcs</p>	<p>FTX8439 – Spur Gear. 1 pc</p>



PARTS LISTING

<p>FTX8304 – Rear Link Holder. 1 pc</p> 	<p>FTX6484 – Pin (8 x 2), 10 pcs</p> 	<p>FTX8308 – Front/Rear Axle Housing. 1 pc</p> 	<p>FTX8309 – Front/Rear Axle Cover. 1 pc</p> 
<p>FTX8310 – Axle Adaptor. 2 pcs</p> 	<p>FTX8311 – Holder for Shock Support Rod. 2 pcs</p> 	<p>FTX8494 – Front & Rear Shocks. 2 pcs</p> 	<p>FTX8338 – Rear Diff. Shaft. 1 pc</p> 
<p>FTX6207 – Front/Rear Shock Shaft & Piston Set. 2 sets</p> 	<p>FTX6209 – Front/Rear Shock Body. 2 pcs</p> 	<p>FTX6210 – Upper Shock Cap. 2 sets</p> 	<p>FTX6211 – Lower Shock Cap. 2 sets</p> 
<p>FTX6212 – Lower Shock Holder & Adjust Ring. 2 sets</p> 	<p>FTX6228 – Diff. Case. 2 pcs</p> 	<p>FTX6229 – Diff. Drive Spur Gear. 2 pcs</p> 	<p>FTX6230 – Diff. Drive Gear. 2 pcs</p> 
<p>FTX8317 – Rear Short Driveshaft. 1 pc</p> 	<p>FTX8318 – Rear Short Driveshaft. 1 pc</p> 	<p>FTX8313 – Axle Housing to Chassis Link Set. 2pcs</p> 	<p>FTX6234 – Washer. 6 pcs</p> 
<p>FTX6597 – Wheel Hub. 4 pcs</p> 	<p>FAST103B – Antenna Pipe Set. 2 sets</p> 	<p>FTX8424 – Slipper Shaft (EBD). 1 pc</p> 	<p>FTX6550 – Body Clip (medium Size). 6 pcs</p> 



























PARTS LISTING

<p>FTX8441 – Pinion gear 20T, 1 pc</p> 	<p>FTX8441 – Gearbox Housing Set, 2 pcs</p> 	<p>FTX8442 – 2-speed transmission gear set</p> 	<p>FTX8443 – 2-speed motor plate</p> 
<p>FTX8444 – 2-speed servo mount</p> 	<p>FTX8445 – 2-speed shift plate</p> 	<p>FTX8446 – 2-speed shaft set</p> 	<p>FTX8447 – 2-speed servo saver set</p> 
<p>FTX8448 – 2-speed gear cover</p> 	<p>FTX6247 – Servo Horns, 2 pcs</p> 	<p>FASTM3 – Nyloc Nut-M3, 6 pcs</p> 	<p>FASTM4 – Nyloc Nut-M4, 6 pcs</p> 
<p>FTX8339 – Battery Case, 1 pc</p> 	<p>FTX8346 – Velcro Tape, 2 pcs</p> 	<p>FTX8490 – Clear Body only, 1 pc</p> 	<p>FTX8491S – Painted Body only, 1 pc</p> 
<p>FTX6500 – Shock Ball End, 6 pcs</p> 	<p>FTX6501 – Servo Link Ball End, 6 pcs</p> 	<p>FTX6502 – Steering Linkage Ball End, 6 pcs</p> 	<p>FTBB11 – Ball Bearing (11x5x4mm), 1 pc</p> 
<p>FTX8342 – Pin 2x13, 6 pcs</p> 	<p>FTX8345 – Washer (8x5x0.2mm), 6 pcs</p> 	<p>FTX6875 – Button Head Hex Screw M2.5x10, 6 pcs</p> 	<p>FTX6516 – E-Clip-4mm, 6 pcs</p> 





















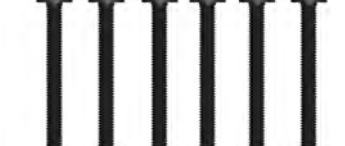



PARTS LISTING

<p>FTX6517 – E-Clip-2.5mm. 6 pcs</p> 	<p>FTX6506 – Ball A. 6 pcs</p> 	<p>FTX6507 – Ball B. 6 pcs</p> 	<p>FTX6508 – Ball C. 6 pcs</p> 
<p>FTX6510 – Shock O-Ring (Lower). 6 pcs</p> 	<p>FTX6511 – Diff. O-Ring Seal. 6 pcs</p> 	<p>FTX6512 – Shock Seal Cover. 4 pcs</p> 	<p>FTX6513 – Pin 2x10. 6 pcs</p> 
<p>FTBB10 – Ball Bearing 15x10x4. 6 pcs</p> 	<p>FTBB16 – Ball Bearing 10x5x4. 6 pcs</p> 	<p>ET0220 – Wall Charger 1000mAH (UK Plug) ET0220E – Wall Charger 1000mAH - (Euro Plug).1 pc</p> 	<p>FTX6523 – Button Head Hex Tapping Screws 3x10. 8 pcs</p> 
<p>FTX8433 – Reciever (Rx) Case. 1 set</p> 	<p>FTX6556W – 9kg Servo. 1 pc</p> 	<p>VZ0010 – Battery pack. 1 pc</p> 	<p>FTX6557W2</p> 
<p>FTX8469 – 550 36T Brushed Motor. 1 pc</p> 	<p>FTX8492 – LED Lights Set. 1 set</p> 	<p>FTX6545 – Screw Set-M3x10. 6 pcs</p> 	<p>FTX-SCH043 – Cap Head Hex Screw- M3x23. 6 pcs</p> 
<p>FAST123A – Screw Set-M4x4. 6 pcs</p> 	<p>FTX-SCH051 – Cap Head Hex Screw- M3x23. 6 pcs</p> 	<p>FTX6519 – Round Head Self-Tapping Hex Screw-2x10. 6 pcs</p> 	<p>FTX6522 – Round Head Self-Tapping Hex Screw M3x6. 6 pcs</p> 

























PARTS LISTING

<p>FTX-SBH043 – Button Head Hex Screw- M3x8. 6 pcs</p> 	<p>FTX-SBH0444 – Button Head Hex Screw- M3x10. 6 pcs</p> 	<p>FTX-SBH046 – Button Head Hex Screw- M3x14. 6 pcs</p> 	<p>FTX6542 – Cap Head Hex Screw- M3x10. 6 pcs</p> 
<p>FTX-SCH046 – Cap Head Hex Screw- M3x14. 6 pcs</p> 	<p>FTX-SCH049 – Cap Head Hex Screw- M3x18. 6 pcs</p> 	<p>FTX-SFH043 – Flat Head Hex-M3x8. 6 pcs</p> 	<p>FTX-SFH049 – Flat Head Hex Screw- M3x18. 6 pcs</p> 
<p>FTX-SFH046 – Flat Head Hex Screw- M3x14. 6 pcs</p> 	<p>FTX-SFH050 – Flat Head Hex Screw- M3x20. 6 pcs</p> 	<p>FTX-SCH046 – Cap Head Hex Screw- M3x14. 6 pcs</p> 	<p>FTX-SBH056 – Button Head Hex Screw- M3x30. 6 pcs</p> 
<p>FTX-SBH058 – Button Head Hex Screw- M3x34. 6 pcs</p> 	<p>FTX6548 – Umbrella Head Screw- M3x6. 6 pcs</p> 	<p>FTX6546 – Flat Head Self-Tapping Screw Set-3x10mm. 12 pcs</p> 	<p>FTX-SCH044 – Cap Head Hex Screw- M3x10. 6 pcs</p> 
<p>FTX-SBH045 – Button Head Hex Screw- M3x12. 6 pcs</p> 	<p>FTX-SCH053 – Cap Head Hex Screw- M3x25. 6 pcs</p> 	<p>FTX-SFH042 – Flat Head Hex-M3x6. 6 pcs</p> 	<p>FTX8470 – Front Body Bracket (Al.). 1 pc</p> 
<p>FTX8471 – Rear Body Bracket (Al.). 1 pc</p> 	<p>FTX8472 – Body posts. 1 set</p> 	<p>FTX8473 – Front Light Bracket. 1 set</p> 	<p>FTX8474 – Rear Light Bracket. 1 set</p> 





















PARTS LISTING

<p>FTX8475 – Mudguard & Pedal. 1 set</p> 	<p>FTX8476 – Rescue Rings. 4 pcs</p> 	<p>FTX8477 – Rear Bumper. 1 pc</p> 	<p>FTX8478 – Front Bumber. 1 pc</p> 
<p>8479R – Front Exhaust Plate. 1 set</p> 	<p>FTX8480 – Head Light Bracket. 5 pcs</p> 	<p>FTX8481 – Body Bracket Post. 4 pcs</p> 	<p>FTX8482 – Roll Cage w/Light Bracket & Tray. 1 set</p> 
<p>FTX8483 – Plastic Tray. 1 pc</p> 	<p>FTX8484R – Head Light Bracket Support. 3 pcs</p> 	<p>8485R – Body Side Frame. 2 pcs</p> 	<p>8486R – Body Top Frames. 5 pcs</p> 
<p>FTX8487 – Door Mirrors. 2pcs</p> 	<p>FTX8488R – Clear Body w/Roll Cage, Tray & Light Bracket. 1 set</p> 	<p>FTX8489R – Painted Body w/Roll Cage, Tray & Light Bracket. 1 set</p> 	<p>FTX8493 – Rear Shock Spring. 2 pcs</p> 
<p>FTX8467 – Upgrade Diff. Locker. 1 pc</p> 	<p>FTX-SFH044 – Flat Head Hex Screw-M3x10. 8 pcs</p> 	<p>FTX8440-A 2-speed Gearbox set w/motor & servo</p> 	<p>FTX8440-B 2-speed Gearbox set w/o motor & servo</p> 
<p>FTX8411 – Central CVD Outer Half. 1 set FTX8411S – Central CVD Outer Half w/steel Coupler. 1 set</p> 	<p>FTX8305 – Central CVD Inner Half. 1 set FTX8305S – Central CVD Inner Half w/Steel Coupler. 1 set</p> 		



UPGRADE PARTS LISTING

<p>FTX8495 – Aluminium Front Shocks. 2 pcs</p> 	<p>FTX8381 – Aluminium Rear Link Holder. 1 pc</p> 	<p>FTX8383 – Aluminium Axle Adaptor. 2 pcs</p> 	<p>FTX8385 – Aluminium Rear Axle Housing. 1 pc</p> 
<p>FTX8387 – Aluminium Rear Axle. 2pcs</p> 	<p>FTX8386 – Aluminium Holder for Rear Shock Support. 2 pcs</p> 	<p>FTX6365W – Aluminium Wheel Hub. 4 pcs</p> 	<p>FTX6367 – Aluminium Steering Arms. 2 pcs</p> 
<p>FTX8450 – Main Frame. 2 pcs</p> 	<p>FTX8498 – Aluminium Chassis Plate. 1 pc</p> 	<p>FTX8452 – Central CVD Set. 2 pcs</p> 	<p>FTX8453 – Battery Case Holder. 2 pcs</p> 
<p>FTX8454 – Aluminium Servo Mount. 1 pc</p> 	<p>FTX8455 – Aluminium ESC Bracket. 1 pc</p> 	<p>FTX8456 – Support Rod Holder L. 2 pcs</p> 	<p>FTX8457 – Support Rod Holder R. 2 pcs</p> 
<p>FTX8458 – Aluminium Steering Knuckles. 2 pcs</p> 	<p>FTX8459 – Steering Rods. 1 pc</p> 	<p>FTX8460 – Aluminium Shocks Lower Support Rod. 1 pc</p> 	<p>FTX8462 – Aluminium Rear Link Set. 2 pcs</p> 
			



MAINTAINING YOUR CAR

After running your car, the following procedures should be performed regularly and will help to maintain your car's performance.

- Inspect your car for any obvious damage.
- Check the gears for wear, debris or broken/slipping teeth.
- Check the wheels and tighten the wheel screws properly.
- Check for loose screws in the chassis.
- Check the wiring for frayed or damaged wires or connectors.
- Check the steering servo which will wear out over time and require replacement.
- Check all batteries.
- Keep the chassis clean and free of sand, dust and moisture.
- Remove and clean the motor if necessary. (Never attempt to re-assemble the motor, you will damage it and void the warranty).
- Clean the car body with a soft lint-free cloth.
- Remove all batteries when not in use.

TROUBLESHOOTING

SYMPTOM

POSSIBLE CAUSE

A. The vehicle does not work at all.

1. Check to see if transmitter and car are on.
2. Replace batteries.
3. Check if there are damaged parts.

B. The vehicle runs slow.

1. Replace or charge the battery pack and/or the radio batteries.
2. Make sure the vehicle is geared properly and the pinion and spur gear are over tightened.
3. Clean all bushings or ball bearings.
4. Check for stripped or dirty gears.

C. The throttle works, but not the steering.

1. Check if the servo feels jammed – try centering it by hand.
2. Check the whole steering system.

D. It steers, but throttle is uncontrollable.

1. Check if there are damaged parts.
2. Replace or charge the battery pack and/or the radio batteries

E. The vehicle runs noisily.

1. Check gear mesh between spur gear and pinion.
2. Check for stripped and/or dirty gears.
3. Clean and oil bushings or ball bearings.



www.ftx-rc.com

